

# CENTER<sup>®</sup> 512

Data Logger  
Carbon Dioxide (CO<sub>2</sub>)  
Meter (NDIR)



Instruction Manual  
SE-512

# CONTENTS

---

TITLE	PAGE
<b>1. General Description</b> .....	1
<b>2. Safety Information</b> .....	1
<b>3. Features</b> .....	1
<b>4. Specifications</b> .....	2
<b>5. Symbol Definition and Button Location</b> .....	3
<b>6. Button Instructions</b> .....	5
6.1 Power ON/OFF and Back-Light button.....	5
6.2 Data-Hold button.....	5
6.3 REC button.....	5
6.4 MAX/MIN/AVG Button.....	5
6.5 SETUP Button.....	6
6.6 °C/°F Button.....	6
<b>7. Operating Instructions</b> .....	6
7.1 Setup Options.....	6
7.2 Menu Item.....	6
7.3 Menu Description.....	8
7.3.1 Setting interval time for data storing.....	8
7.3.2 Set offset to compensate for errors.....	8
7.3.3 Set altitude compensation.....	8
7.3.4 Set alarm point.....	9
7.3.5 Set auto power off time.....	9
7.3.6 Set system clock.....	10
7.4 Clearing data logger records.....	10
7.5 Connecting to computer.....	10
<b>8. Calibration Procedure</b> .....	11
<b>9. Power Repairation</b> .....	12
9.1 Battery Replacement.....	12
<b>10. Maintenance</b> .....	12
<b>11. SE-512 Software</b> .....	13
<b>12. CO<sub>2</sub> Levels And Guidelines</b> .....	19

## 1. GENERAL DESCRIPTION

Thank you for choosing our Carbon Dioxide (CO<sub>2</sub>) Meter. To ensure the safety and the best performance of this instrument, we recommend you to read and follow the manual carefully before operation.

Data can be stored in the meter or directly saved on a computer through PC interface. Recorded data can be further processed by PC computer.

## 2. SAFETY INFORMATION

Read the following safety information carefully before attempting to operate or service the meter. Use the meter only as specified in this manual; otherwise, the protection provided by the meter may be impaired.

### ENVIRONMENT CONDITIONS

- Altitude up to 2000 meters
- Relatively humidity: 90% max
- Operation ambient temperature: 0°C to 50°C

### MAINTENANCE & CLEARING

- Repairs or servicing not covered in this manual should only be performed by qualified personnel.
- Periodically wipe the case with a dry cloth. Do not use abrasives or solvents on this instrument.

### SAFETY SYMBOLS

 Comply with EMC

When servicing, use only specified replacement parts.

## 3. FEATURES

- CO<sub>2</sub>, humidity and temperature sensors.
- Dual wavelength NDIR CO<sub>2</sub> sensor (Non-Dispersive Infrared) for superior stability.
- User operated CO<sub>2</sub> calibration.
- Data Hold & Max/Min/STEL/TWA function.
- Adjustable auto power off timer.
- Internal CO<sub>2</sub> alarm buzzer.
- Datalogging up to 32,000 sets.
- USB interface, PC software included.
- Backlight display function.

## 4. SPECIFICATIONS

### CO<sub>2</sub> SENSOR:

<b>Type</b>	Non-dispersive infra-red (NDIR)
<b>Measurement range</b>	0~30000 ppm
<b>Accuracy</b>	± (75ppm+3% of reading ) (0~5000 ppm) ± (150ppm+5% of reading ) (5001~30000 ppm)
<b>Resolution</b>	1 ppm
<b>Response time</b>	20 s
<b>Sampling rate</b>	2 s

### RELATIVE HUMIDITY SENSOR:

Measurement range	0 ~ 100%
Accuracy	± 4.5% RH (20~80%) ± 5.5% RH (<20%,>80%) (in still air)
Resolution	0.1%
Response time	8 s

### TEMPERATURE SENSOR:

Measurement range	0 to 50 °C (32 to 122°F)
Accuracy	±1.0°C (@23 ± 5°C) (in still air)
Resolution	0.1°C /0.1°F
Response time: (1/e)	10 s
<p>Temperature Coefficient: For ambient temperatures from 0°C ~ 18°C and 28°C ~ 50°C, add the following tolerance into the accuracy spec for each °C ambient below 18°C or above 28°C:            0.01% of reading + 0.03°C            0.01% of reading + 0.06°F</p>	
Battery type	9V Alkaline battery
Battery lifetime	Approx. 10 hours (alkaline battery)
Operation temperature	0°C to 50°C (32°F to 122°F)
Operation humidity	10 to 90%RH (no condensing)
Storage temperature	-20°C to 60°C (-4°F to 140°F)
Storage humidity	10 to 75%RH
Dimensions/ Weight	226.5(L)x65(W)x38.5(H)mm / Approx. 273g
Standard accessories	9V alkaline battery · Instruction manual · Windows software · micro USB cable · Carrying case

## 5. SYMBOL DEFINITION & BUTTON LOCATION

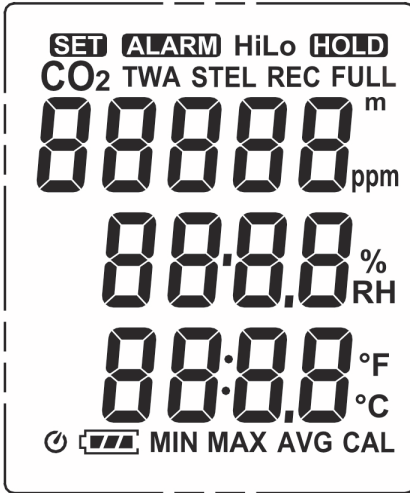

: Battery condition indicator

**MIN**

: Minimum indicator

**MAX**

: Maximum indicator

**STEL**

: Short-term exposure limit indicator

**TWA**

: Time weighted average indicator

**SET**

: Setup option indicator



: Auto power off enabled indicator

**REC**

: Recording data logger indicator

**FULL**

: Memory full indicator

**00000**: CO<sub>2</sub> reading**00.00**

: Relative Humidity/Temperature reading

**ALARM**: CO<sub>2</sub> alarm indicator**Hi**: Hi CO<sub>2</sub> alarm indicator**Lo**: Lo CO<sub>2</sub> alarm indicator**HOLD**

: Data hold indication

**ppm**: CO<sub>2</sub> measurement unit**m**

: Altitude meter unit

**°C °F**

: Temperature measurement unit

**% RH**

: Relative Humidity measurement unit

**CAL**

: Calibration mode

**CO<sub>2</sub>**: CO<sub>2</sub> measurement indicator

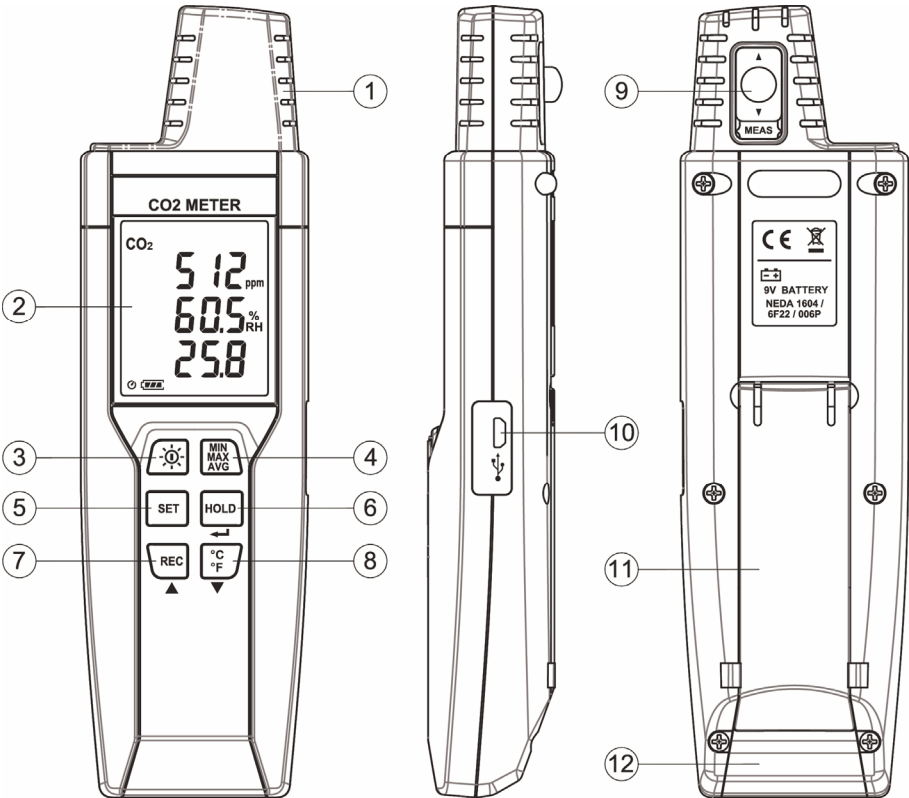

- |                               |                       |
|-------------------------------|-----------------------|
| ① CO <sub>2</sub> Sensor      | ⑦ REC Button          |
| ② Display Screen              | ⑧ °C/°F Button        |
| ③ Power and Back Light Button | ⑨ Calibration inlet   |
| ④ MAX MIN AVG Button          | ⑩ USB Interface       |
| ⑤ SETUP Button                | ⑪ Tilt Stand          |
| ⑥ DATA HOLD Button            | ⑫ Battery Compartment |

### **Notice before operation!**

*Temperature and humidity readings will be more accurate after 10 minutes when powering on (warm-up time).*

*Temperature and humidity readings could be affected by long-time-exposure under VOC environment.*

## 6. BUTTON INSTRUCTIONS



### 6.1 Power ON/OFF and Back-Light Button:

Press the  button to turn on the meter. Press and hold the button for 3 seconds to turn off.

Press  to turn on the LCD backlight. This makes it easier to read in dark environment. Press it again to turn off back-light. The back-light will be automatically turned off after 30 seconds to save battery power.

### 6.2 Data-Hold Button :

Press  button to freeze the data shown on the LCD screen. Press it again to exit Data-Hold mode.

**Note:** When the unit is in the Data-Hold mode, , , and  buttons are disabled.

### 6.3 REC Button:

Press  button to start recording data. The **REC** symbol will display on the screen. To stop recording, press  button again.

**Note:** During recording period, most of the buttons are disabled, such as the . All settings must be made before starting the data logger function.





**Note:** When the memory is full (32,000 recorders), **FULL** symbol will blink on the LCD screen. The data logger stops.

**Note:** When battery power is low ( " " symbol lights up on the screen), data logger cannot be started. If the battery is running low during data logging, it will stop recording automatically.

### 6.4 MAX/MIN/AVG Button:

Under this mode, the unit simultaneously monitors and stores the minimum, maximum and average value in the memory. The unit will keep updating/refreshing the data.

#### To start:

- (1) Press  button, **MIN** symbol lights up on LCD, the reading shows the minimum data.
- (2) Press  button again to show maximum data; the **MAX** symbol lights up on LCD.
- (3) Press  button again to show average data; the **STEL** symbol lights up on LCD.
- (4) Press  button again to show average data; the **TWA** symbol lights up on LCD.

- (5) Press  button again, the “ **MAX, MIN, STEL and TWA** ” symbol blink together, the readings show real time data.

### To exit MAX/MIN/AVG mode:

Press and hold  button for 2 seconds to exit MAX/MIN/AVG mode.

#### **Note:**

**STEL:** Short-term exposure limit (15 minutes time-weighted average exposure). To update the CO<sub>2</sub> reading per 1 minute.

**TWA:** Time weight average (8 hours time-weighted average exposure). To update the CO<sub>2</sub> reading per 10 minutes.

### 6.5 SETUP Button:

Press the  button to enter setup options. Press  again to exit setup mode at anytime.

**Note:** When the meter is connecting with PC, setup options cannot be entered.







### 6.6 °C / °F Button :

Press  to select the desired unit for temperature.

## 7. OPERATING INSTRUCTIONS

**Note:** Do not hold the meter close to faces in order to avoid exhalation affects reading (CO<sub>2</sub>).

### 7.1 Setup Options:

- (1) Press the  button to enter setup options. Press it again to exit anytime.
- (2) Using the     button to adjust parameters or move setting items.
- (3) Press the   button to save changes and move to next setting option.

### 7.2 Menu Item:



(1) Fig.1 Set interval time for data logging.



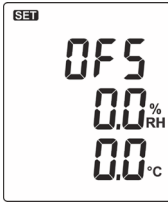

(2) Fig.2 Set Relative Humidity/Temperature offset.

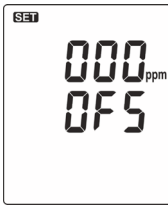

(3) Fig.3 Set CO<sub>2</sub> offset.



(4) Fig.4 Set Altitude compensation.

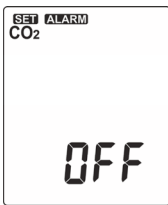

(5) Fig.6 Set alarm point.



(6) Fig.7 Set auto power off time.



(7) Fig.8 Set system clock.

## 7.3 Menu Description:

### 7.3.1 Setting interval time for data storing:

- (1) Press the / button to increase / decrease minute value.
- (2) Press the button.
- (3) Press the / button to increase / decrease second value.
- (4) Press the button to set interval.

#### **Note:**

Set interval time range: 1 Second (00:01) to 60 minutes 59 seconds (60:59).

### 7.3.2 Set offset to compensate for errors:

The user can adjust the readings to compensate for the errors.



- (1) Press the / button to increase / decrease %RH value.
- (2) Press the button.
- (3) Press the / button to increase / decrease temperature value.
- (4) Press the button.
- (5) Press the / button to increase / decrease CO<sub>2</sub> value.
- (6) Press the button to set all offset.

#### **Note:**

The offset to compensate for probe errors range:  $\pm 10\%$ RH  $\cdot$   $\pm 5^{\circ}$ C or  $\pm 9^{\circ}$ F  $\cdot$   $\pm 400$  ppm.

### 7.3.3 Set altitude compensation:

- (1) Press the / button to increase / decrease 1st digit value (0-9).
- (2) Press the button.
- (3) Press the / button to increase / decrease 2nd digit value (0-9).
- (4) Press the button.
- (5) Press the / button to increase / decrease 3rd digit value (0-9).

- (6) Press  the button.
- (7) Press the  button to increase / decrease 4th digit value (0-3).
- (8) Press  the button to set altitude compensation.

**Note:**

Set altitude compensation range: 0 ~ 3000m

The factory default setting is at zero.

Please check and set the correct value before measuring.

**7.3.4 Set alarm point:**

Want to set window. (see Fig.9 or Fig.10)

- (1) Press the  button to turn ON or OFF.
- (2) When setting on mode, press the  button to set Hi and Lo limit.

(CO2 alarm setting see Fig.11 and Fig.12)



Fig.9

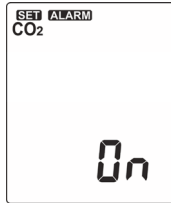

Fig.10

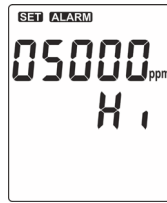

Fig.11



Fig.12

**Note:**

When the measuring values go beyond alarm point, the symbol will blink “ **ALARM Hi** ” or “ **ALARM Lo** ” on the LCD.

The beeper will make “ beep-beep-beep ” sound.

The Lo alarm set cannot be greater than Hi alarm set.

**7.3.5 Set auto power off time:**

Press the  button to select auto power off option 10, 30 minutes, 1, 2, 4, 8 hours, or off.

(See Fig.13 or Fig.14)

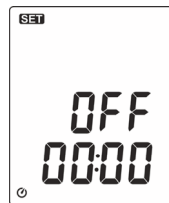

Fig.13





Fig.14

**Note:**

The Auto-power off function will automatically turn off while the meter is in REC and MAX/MIN/AVG mode or being powered by USB cable.

### 7.3.6 Set system clock:

The clock for the unit is built-in so that the data logger function can also record the data and time along with the measurement value.

(1) Press the   button to select year, date, or time.

(See Fig.15)

(2) Press the   /   button to increase / decrease value.





Fig.15



#### **Note:**

Check the clock setting after replacing batteries. If necessary, reset system clock.

### 7.4 Clearing Data Logger Records:

(1) Turn off the unit.

(2) Press and hold  button and then press  power button to turn on the unit.

(3) Keep holding  and  button, then LCD will show " REC ", " CLr " and " **SUR 5, 4...1, 0** " until clean the memory. (To abort, release all buttons in process)

### 7.5 Connecting to a computer:

The meter can be connected to PC through a micro USB cable to download recorded data or perform real time monitoring or datalogging in the software interface.

## 8. CALIBRATION PROCEDURE

The CO<sub>2</sub> span gas can be in the range of 0 - 2000 PPM, 2% accuracy, with balance air.

Make sure the concentration of the calibration gas is within the range of each sensor. Do not use gas that could over-range the sensor.

For better accuracy, it is recommended that you use a span gas value close to the gas concentration you expect to measure.

Please use a new battery during the calibration to prevent interruption or failed calibration.

**Switch to CAL ⇒ Take out the protection cap ⇒ Connecting to a standard concentration**

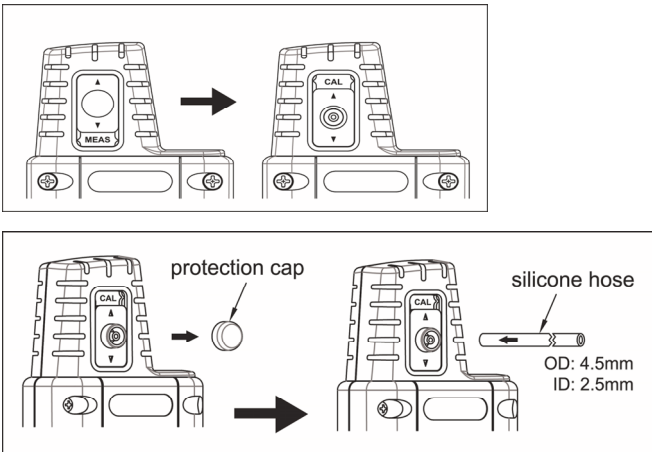

- (1) Turn off the meter.
- (2) Press the **SET** + **MIN MAX AVG**, then press **0.0** button for 3 seconds.
- (3) LCD indicator: - - -
- (4) In 3 seconds, press **SET** → **°C / °F** → **°C / °F** to enter calibration mode.
- (5) LCD line1 indicator: CO<sub>2</sub> real time reading.
- (6) LCD line2 symbol blinking: Press the **REC** ▲ / **°C / °F** ▼ button to increase / decrease value.
- (7) Please wait at least 2 minutes and then press the **HOLD** ← button.
- (8) If there are no error messages appear in the end, LCD shows "**PASS**".
- (9) Press **SET** anywhere to exit calibration mode.

## 9. POWER PREPARATION

### 9.1 Battery Replacement:

(1) When the battery voltage drops below proper operation range, the  symbol will blink on the LCD display and the battery needs to be replaced.

(2) Before replacing the battery, power off the meter.

Open the cover of the battery cabinet. Replace the old batteries with new 9V Alkaline battery (Carbon-zinc batteries are not recommended).

(3) Close the battery cabinet cover.

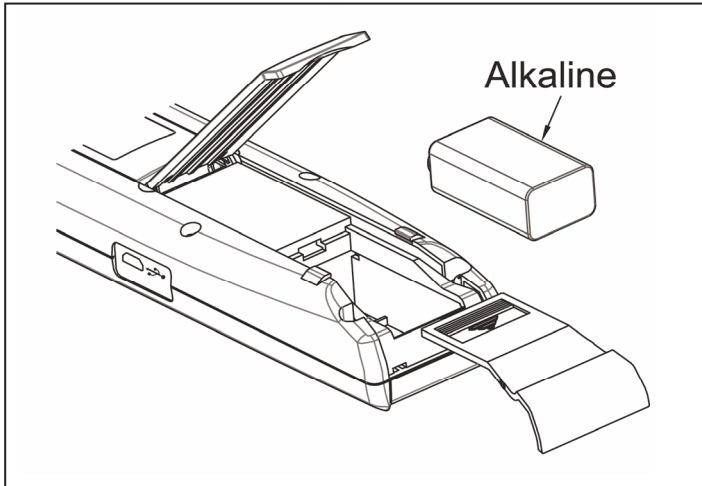

## 10. MAINTENANCE

In order to ensure the accuracy of the NDIR CO<sub>2</sub> Meter for a longer period of time you should calibrate it once a year.

Clean the device and the window of the display with a clean, lint-free, antistatic and dry cleaning cloth.

**⚠ Do no use cleaning agents that contain carbon or benzenes, alcohol or anything similar to clean the product since these substances damage the surface of the measuring instrument. Moreover, these fumes are hazardous to health and explosive. Do not use tools with sharp edges, screwdrivers, metal brushes or anything similar to clean the device.**

## 11. SE-512 SOFTWARE

### 11.1 The SE-512 package contains:

- Software CD disk.
- Micro USB cable.

### 11.2 System Required:

Windows 7/ Windows 8/ Windows 10

### 11.3 Minimum Hardware Required:

- PC or laptop with CD-ROM drive.
- At least 50 MB hard disk space available to install SE512.
- Recommended screen resolution 1024X768 or above.

### 11.4 Tutorial - Quick Start to Use SE512:

#### Recording real time data in waveform:

- (1) Power on the NDIR CO<sub>2</sub> Meter first and connect it to a PC USB port with the cable.
- (2) Start SE512 program.
- (3) If the connection is successful, the panel will display the same value as NDIR CO<sub>2</sub> Meter. If fail to connect the meter with PC, it will display " **No Connection** " on the panel window in SE512.
- (4) Select sampling rate from Real-Time Graph window.

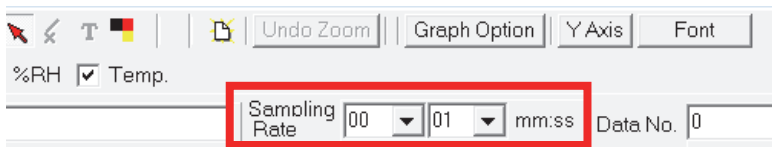
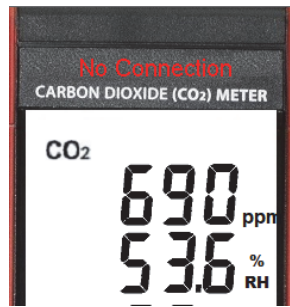

(5) When the connection is successful, click " **Real Time | run** " or  from main menu to start recording real time data and there will be a waveform on the Real Time Graph Window.

(6) Click " **Real Time | Stop** " or  to stop recording.

## 11.5 How to save the recorded real time data to a file?

(1) Click the graph window you want to save and the graph window will become active, then choose File | Save from main menu or click from the tool bar.

### an active window

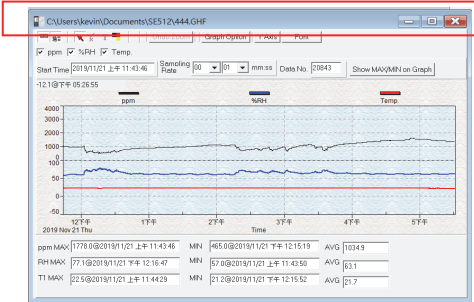

### not active window

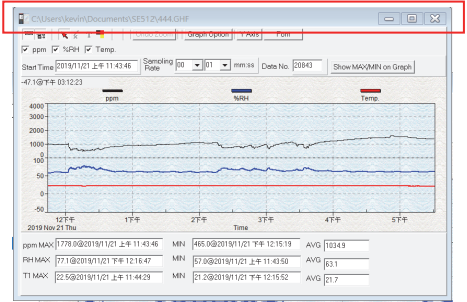

(2) There will be a save dialog window for you to choose the file name and file type to save. There are three types of file format you can choose, binary file(\*.ghf), text file(\*.txt) and EXCEL format file(\*.csv). The \*.ghf file use much fewer disk space to save the data than the other two file formats, but it can only be used in SE512. Text file can be opened by SE512 and any other word processor program like word, notepad etc. EXCEL format file can be opened by SE512 and Microsoft EXCEL.

**Note:** If decimal separator is comma in your country, this file format will be disabled, because .CSV file also use comma to be data separator. For example 78,6 will become 78 and 6 in EXCEL.

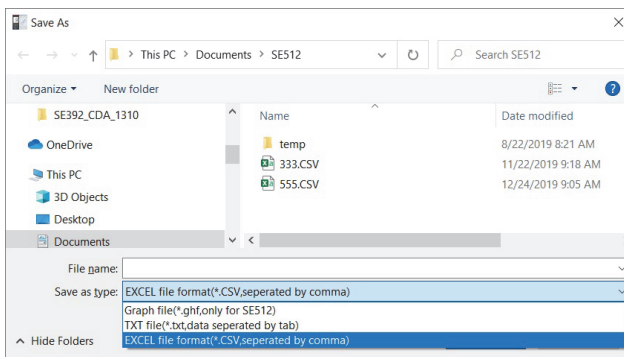



## 11.6 How to load the recorded data from the memory of Carbon Dioxide (CO<sub>2</sub>) Meter and save it to a file?

- (1) Power on the Carbon Dioxide (CO<sub>2</sub>) Meter.
- (2) Press the **REC** button of the meter to start recording data.
- (3) After a while, press **REC** button again to stop recording data.
- (4) Connect the meter to PC.
- (5) Start SE512 program.
- (6) Choose Data Logger from main menu or click  from tool bar.

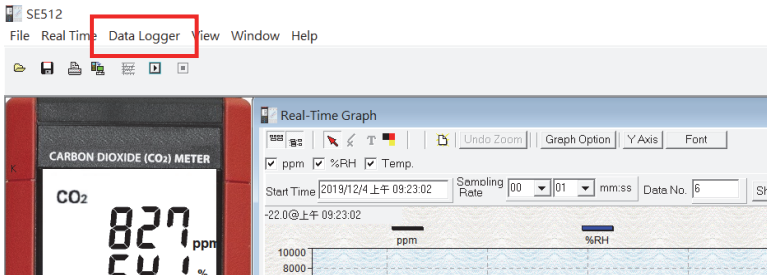

- (7) In reference to Data Logger, see DataLogger.

## 11.7 Main Menu:

File Real Time Data Logger View Window Help

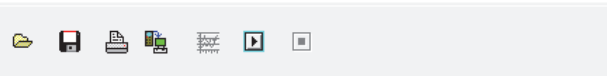

**File | Open**- Retrieve files from the disk.



**Save** - Save the active window (when the caption bar is highlighted) data to the disk.



**Print** - Print the data of the active window (graph or list).

**Printer Setup** - Select printer.

**File | Exit**: Terminates program.

**View | Control Panel:**

By opening the Panel Window, the user can control meter via the button in this window.

**View | Real-Time Graph:**

Open Real-Time Graph display to graph the present data.



**Real Time Data | Run** - Start collecting real time data.



**Stop** - Stop collecting real time data.



**DataLogger:**

By opening the DataLogger Window, the user can load recorded data of meter to PC in this window.



**Output To Graph** - Graphing tabular data.

## 11.8 DataLogger:

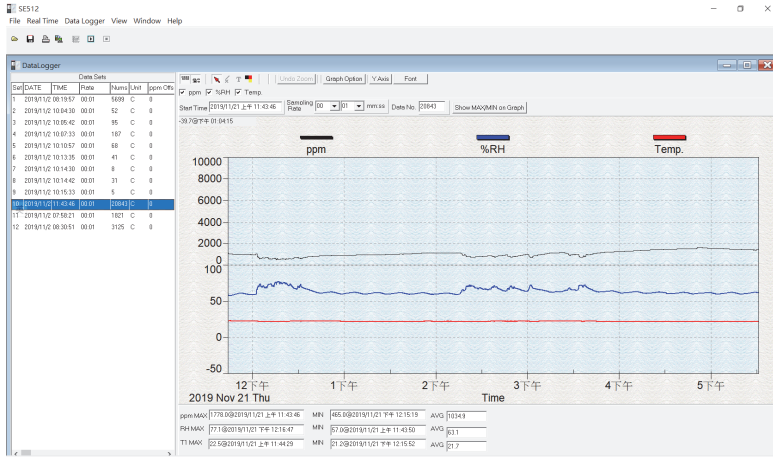

When you have the Carbon Dioxide (CO<sub>2</sub>) Meter connected to PC, select " **DataLogger** " from main menu or click Datalogger icon from tool bar to load recorded data from the meter and there will be a progress indicator to show the loading status. If error occurs, just click " **DataLogger** icon " again.

After the data was downloaded, the left hand side will show how many data sets were loaded and detail information for each data set (start data, start time, recording rate and record numbers).

for examples:

Data Sets								
Set	DATE	TIME	Rate	Nums	Unit	ppm Offset	RH Offset	T1 Offset
1	2019/11/2	08:19:57	00:01	5699	C	0	0.0	0.0
2	2019/11/2	10:04:30	00:01	52	C	0	0.0	0.0
3	2019/11/2	10:05:42	00:01	95	C	0	0.0	0.0
4	2019/11/2	10:07:33	00:01	187	C	0	0.0	0.0
5	2019/11/2	10:10:57	00:01	68	C	0	0.0	0.0
6	2019/11/2	10:13:35	00:01	41	C	0	0.0	0.0
7	2019/11/2	10:14:30	00:01	8	C	0	0.0	0.0
8	2019/11/2	10:14:42	00:01	31	C	0	0.0	0.0
9	2019/11/2	10:15:33	00:01	5	C	0	0.0	0.0
10	2019/11/2	11:43:46	00:01	20843	C	0	0.0	0.0
11	2019/11/2	07:58:21	00:01	1821	C	0	0.0	0.0
12	2019/11/2	08:30:51	00:01	3125	C	0	0.0	0.0

It will generate the first data set to graph on the right hand side. The user can also click at any other data set for graph.

### Graph:

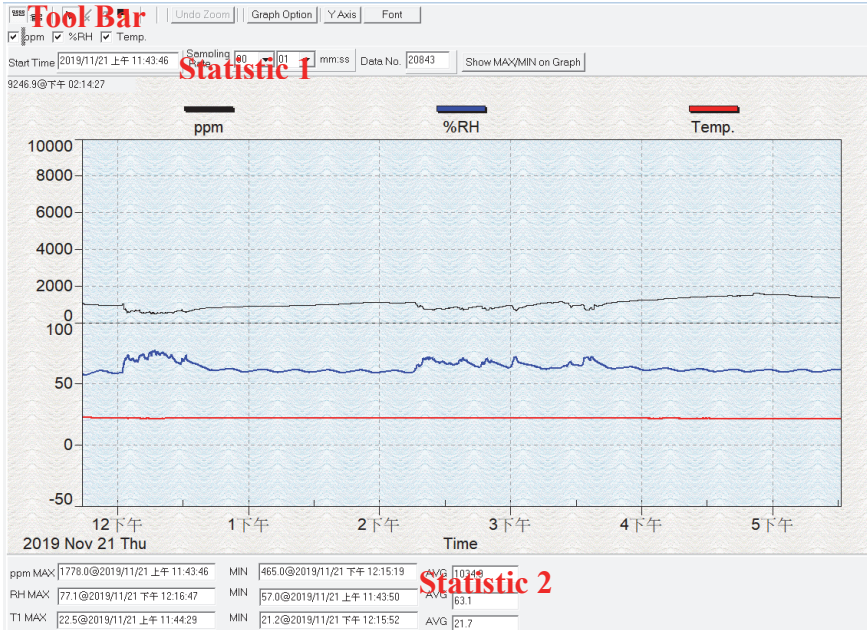

### Tool Bar:



- Display or hide Statistic1.



- Display or hide Statistic2.



- Normal cursor.



- When selected, the mouse cursor will become a cross sign when moving to the graph, click on the graph to mark a cross sign on the graph. And all the mark you make will exist with ppm.



- When selected, the mouse cursor will become a "I" sign when moving to the graph, click on the graph to annotate. And all the text you make will exist with ppm.

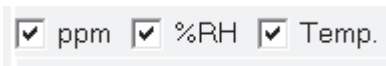

- Select the channel.

**Graph Option** - Graph Customization

**Y Axis** - Change the Y axis extension

**Undo Zoom** - To Undo the Zoom

You can Zoom this graph by using mouse:

To Zoom:

- (1) Press the left mouse button and drag the cursor to select the new extents.
- (2) Release the mouse button.

You can choose channel number showing in the graph.

- a. Click "**Graph Option**" to call Customization dialog.
- b. Select Subsets tab.
- c. Select a single channel or multiselect (hold Ctrl key, use mouse to choose) channels.

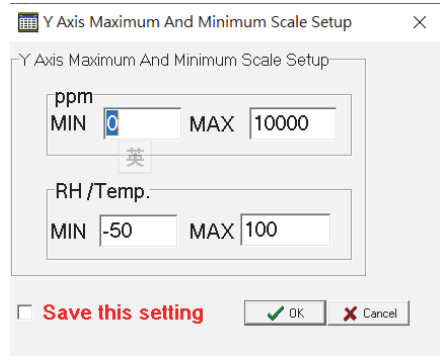

## 11.9 Frequently Asked Question:

### (1) How to uninstall SE512?

**Answer:** Uninstall SE512 by launching the Add/Remove Programs applet out of the Control Panel, highlighting the SE512, and clicking on the Add/Remove... push button, then it will remove the SE512 folder and files from your computer.

### (2) How to zoom the graph?

**Answer:** Press the left mouse button and drag the cursor to select the new extents, then release the mouse button.

### (3) When I setup the real time sampling with a fast rate(eg. 1 sec), some of the sampling data might be lost.

**Answer:** This might be caused by slow response time of the PC interface. For better result, the user may close the panel window.

### (4) How to continue to use the meter when the battery has run down ?

**Answer:** With USB interface powered directly, you can continue to use the meter.

## 12. CO<sub>2</sub> LEVELS AND GUIDELINES

### NIOSH recommendations

250-350 ppm: normal outdoor ambient concentrations.

600 ppm: minimal air quality complaints.

600-1000 ppm: less clearly interpreted.

1000 ppm: indicates inadequate ventilation; complaints such as headaches, fatigue, and eye/throat irritation will be more widespread. 1000 ppm should be used as an upper limit for indoor levels.

### ASHRAE Standard 62-1989: 1000ppm

CO<sub>2</sub> concentration in occupied building should not exceed 1000ppm.

### Building bulletin 101 (BB101): 1500ppm

UK standards for schools say that CO<sub>2</sub> at averaged over the whole day(i.e. 9am to 3.30pm) should not exceed 1500ppm.

### OSHA: 5000ppm

Time weighted average over five 8-hour work days should not exceed 5000ppm.

### Germany, Japan, Australia, UK...: 5000ppm

8 hours weighted average in occupational exposure limit is 5000ppm.

---

***CENTER***® **CENTER TECHNOLOGY CORP.**

4F, NO.415, Jung-Jeng Rd., Shu-Lin Dist., New Taipei City 238, Taiwan  
TEL: 886-2-26763926                      E-Mail : center@centertek.com  
FAX: 886-2-26763925                      http : // www.centertek.com

GCA000512-12000

---